

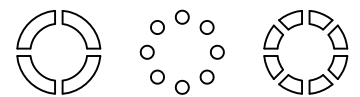

- NOTES :
- 1 . Material : Brass
  - 2 . The tolerance is  $\pm 0.2$  mm
  - 3 . Dimension : 1.0(H)X5.56( $\phi$ )XM2.5
  - 4 . Quantity Per Reel : 2000 /R13"
  - 5 . Plated : Sn Plated

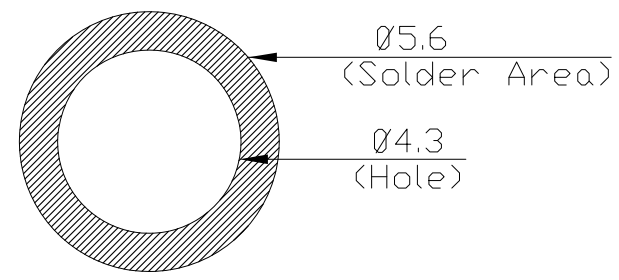
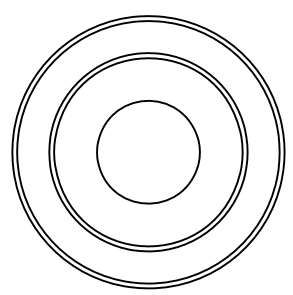
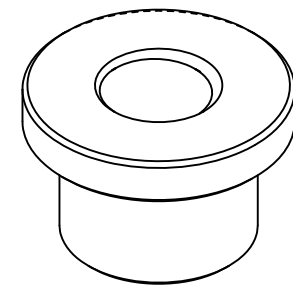
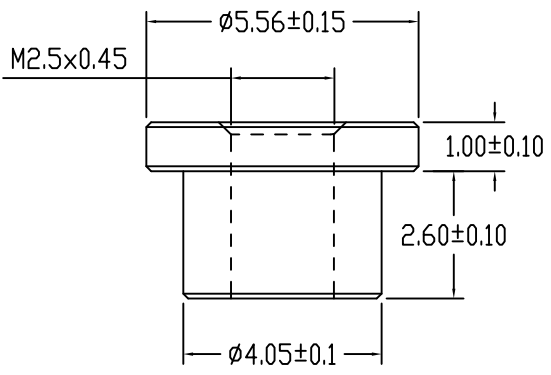

Stencil Masking Examples

PROPRIETARY NOTE: This document contains confidential information and proprietary to Rego Electronics and shall not be reproduced or disclosed to other documents or used for any purpose other than that for which was obtained without the expressed written consent of Rego Electronics.			
.X $\pm 0.30$	APPROVED: Chris	 <a href="http://www.rego.com.tw">http://www.rego.com.tw</a>	
.XX $\pm 0.20$	CHECKED: Andy		
.XXX $\pm 0.15$	DRAWN: Vic		
X* $\pm 3'$			
	UNITS: mm	SCALE: NONE	TITLE: Stand Off $\phi 5.56 \times 3.60$ mm (H:1.0)
			PART NO: SO-M25H10D556
		SHEET: 1 OF 2	

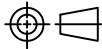
A	05.11.2019
REV	DATE

A

B

C

D

E

F

1. 10 sprocket hole pitch cumulative tolerance  $\pm 0.20\text{mm}$ .
2. Carrier camber not to exceed 1mm in 250mm.
3.  $A_0$  and  $B_0$  measured on a plane 0.3mm above the bottom of the pocket.
4.  $K_0$  measured from a plane on the inside bottom of the pocket to the top surface of the carrier.
5. All dimensions meet EIA-481-B requirements.
6. Material: Black Conductive Polystyrene.
7. Packing length per 22" reel : 51 Meters.(1:3)
8. Component load per 13" reel : 2000pcs.

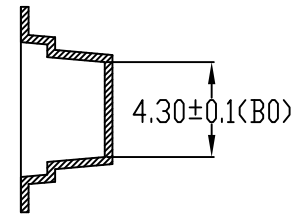
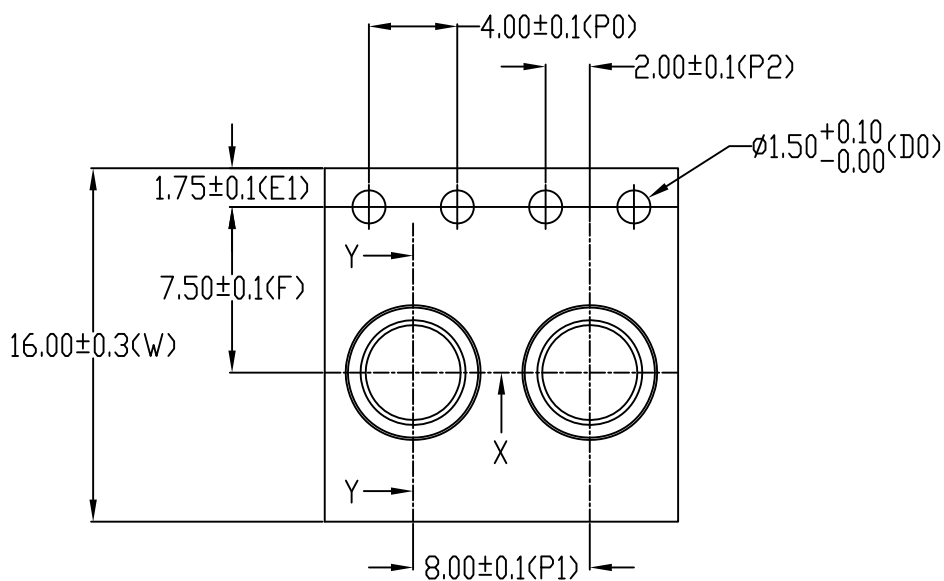

SECTION Y-Y

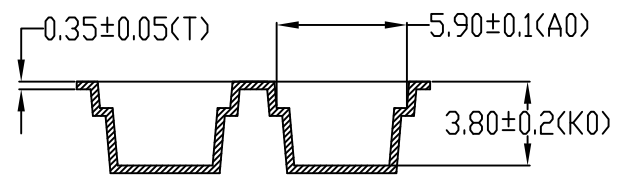

SECTION X-X

# RATIO 2 : 1

A	05.11.2019
REV	DATE

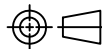
<b>PROPRIETARY NOTE:</b> This document contains confidential information and proprietary to Rego Electronics and shall not be reproduced or disclosed to other documents or used for any purpose other than that for which was obtained without the expressed written consent of Rego Electronics.			
.X ± 0.30	APPROVED:	Chris	 <a href="http://www.rego.com.tw">http://www.rego.com.tw</a>
.XX ± 0.20	CHECKED:	Andy	
.XXX ± 0.15	DRAWN:	Vic	
X* ± 3'	UNITS:	SCALE:	TITLE: Stand Off Ø5.56 x 3.60mm (H:1.0)
	mm	NONE	PART NO: SO-M25H10D556
			SHEET: 2 OF 2