

1 2 3 4 5 6 7 8 9 10

A  
B  
C  
D  
E  
F

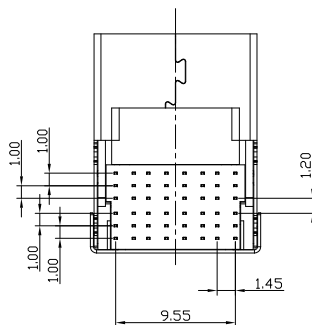
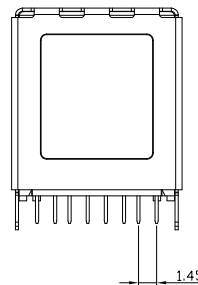
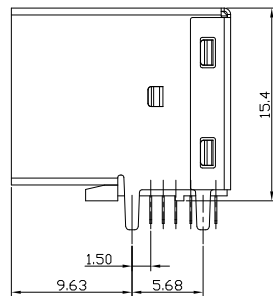
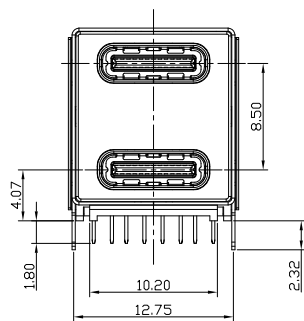
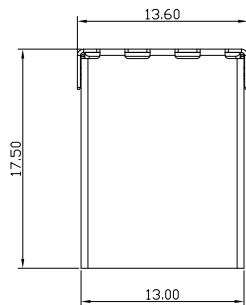

NOTES:

1. HOUSING: LCP, UL 94V-0, COLOR- BLUE (PANTONE 300C).
2. BOTTOM COVER: LCP, UL 94V-0,COLOR- BLUE (PANTONE 300C).
3. CONTACT: COPPER ALLOY,30 $\mu$ " MIN. GOLDPLATED ON CONTACT AREA, 120 $\mu$ " MIN. MATTE TIN PLATED ON SOLDERING TAIL,80 $\mu$ " MIN. NICKEL UNDER-PLATED OVERALL.
4. FRONT SHELL: STAINLESS STEEL, 30 $\mu$ " MIN. NICKEL PLATED OVER ALL, 100 $\mu$ " MIN. MATTE TIN PLATED ON SOLDERING TAIL.
5. MIDDLE SHELL: STAINLESS STEEL.
6. REAR SHELL: STAINLESS STEEL.

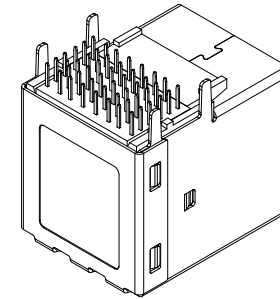
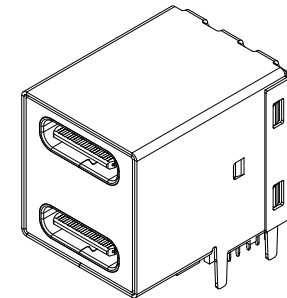

PROPRIETARY NOTE:

This document contains confidential information and proprietary to Rego Electronics and shall not be reproduced or disclosed to other documents or used for any purpose other than that for which was obtained without the expressed written consent of Rego Electronics.

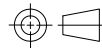
.X $\pm$ 0.30	APPROVED: Chris	 <a href="http://www.rego.com.tw">http://www.rego.com.tw</a>
.XX $\pm$ 0.20	CHECKED: Andy	
.XXX $\pm$ 0.15	DRAWN: Vic	
X* $\pm$ 3*		
	UNITS: mm	SCALE: NONE
		PART NO: 9177USB31-F02005
		SHEET: 1 OF 3

A	21.3.2022
REV	DATE

1 2 3 4 5 6 7 8 9 10

A

B

C

D

E

F

USB TYPE-C FULL-FEATURED RECEPTACLE INTERFACE PIN ASSIGNMENTS

PIN	Signal Name	Description	PIN	Signal Name	Description
A1	GND	Ground return	B12	GND	Ground return
A2	SSTXp1	Positive half of first SuperSpeed TX differential pair	B11	SSRXp1	Positive half of first SuperSpeed RX differential pair
A3	SSTXn1	Negative half of first SuperSpeed TX differential pair	B10	SSRXn1	Negative half of first SuperSpeed RX differential pair
A4	VBUS	Bus Power	B9	VBUS	Bus Power
A5	CC1	Configuration Channel	B8	SBU2	Sideband Use (SBU)
A6	Dp1	Positive half of the USB 2.0 differential pair-Position 1	B7	Dn2	Negative half of the USB 2.0 differential pair-Position 2
A7	Dn1	Negative half of the USB 2.0 differential pair-Position 1	B6	Dp2	Positive half of the USB 2.0 differential pair-Position 2
A8	SBU1	Sideband Use(SBU)	B5	CC2	Configuration Channel
A9	VBUS	Bus Power	B4	VBUS	Bus Power
A10	SSRXn2	Negative half of second SuperSpeed RX differential pair	B3	SSTXn2	Negative half of second SuperSpeed TX differential pair
A11	SSRXp2	Positive half of second SuperSpeed RX differential pair	B2	SSTXp2	Positive half of second SuperSpeed TX differential pair
A12	GND	Ground return	B1	GND	Ground return

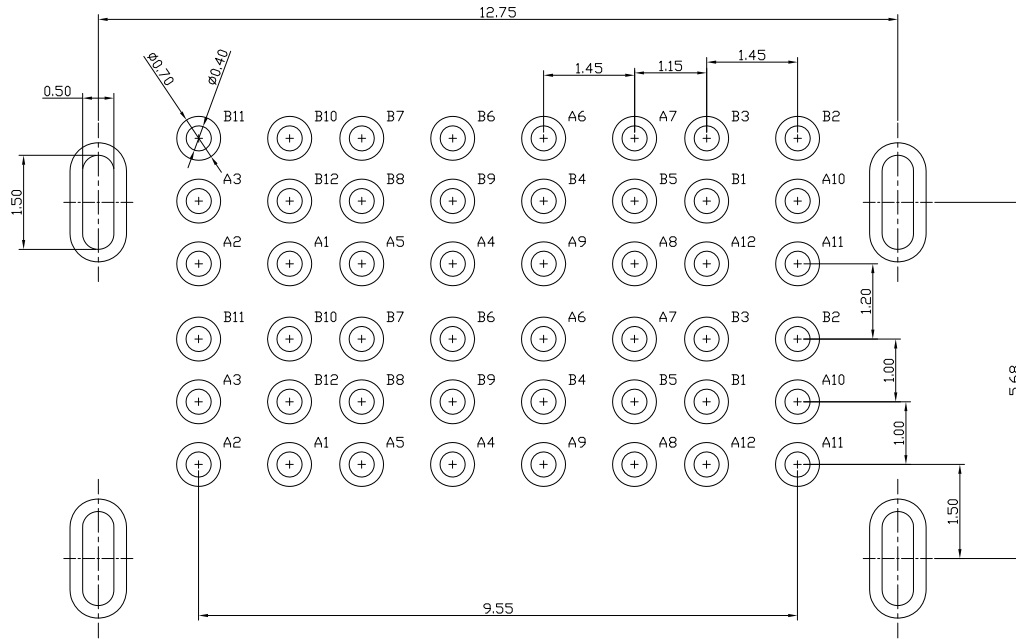



RECOMMENDED PCB LAYOUT(TOP VIEW)  
(DEFAULT TOLERANCE:±0.05)

A	21.3.2022
REV	DATE

PROPRIETARY NOTE:

This document contains confidential information and proprietary to Rego Electronics and shall not be reproduced or disclosed to other documents or used for any purpose other than that for which was obtained without the expressed written consent of Rego Electronics.

.X ± 0.30	APPROVED: Chris	 <a href="http://www.rego.com.tw">http://www.rego.com.tw</a>
.XX ± 0.20	CHECKED: Andy	
.XXX ± 0.15	DRAWN: Vic	
X* ± 3°		
	UNITS: mm	SCALE: NONE
		TITLE: USB Type C 2x1 Port , Right Angle Type
		PART NO: 9177USB31-F02005
		SHEET: 2 OF 3

1 2 3 4 5 6 7 8 9 10

A

B

C

D

E

F

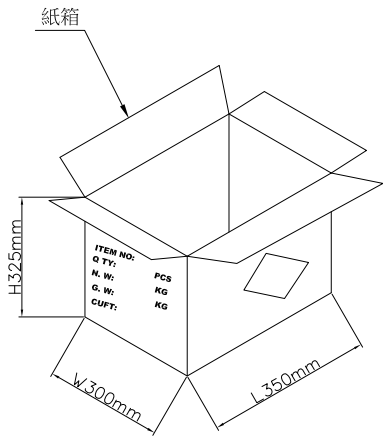
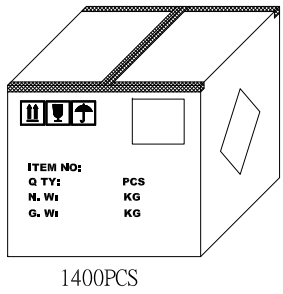
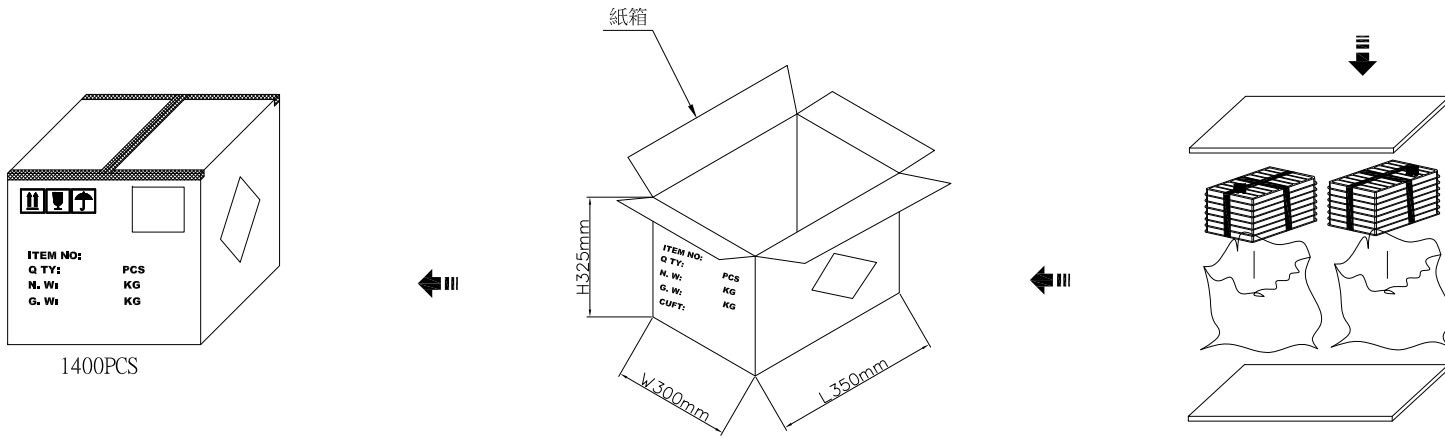
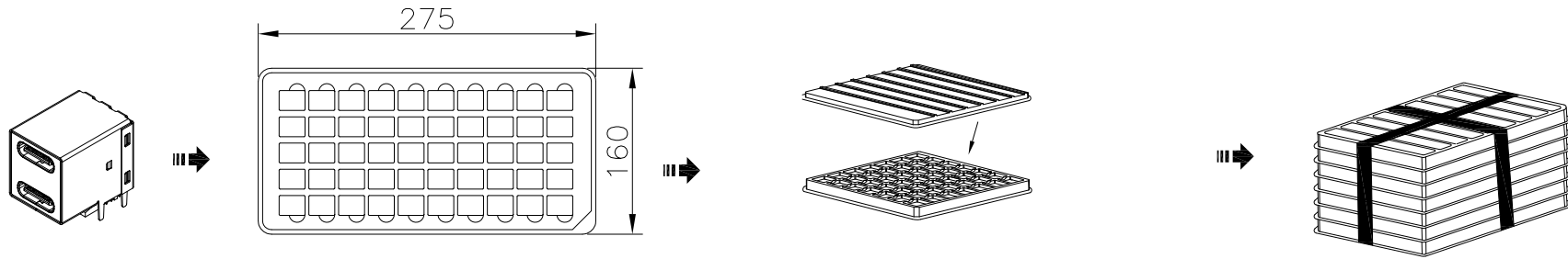

PROPRIETARY NOTE:  
This document contains confidential information and proprietary to Rego Electronics and shall not be reproduced or disclosed to other documents or used for any purpose other than that for which was obtained without the expressed written consent of Rego Electronics.

.X ± 0.30	APPROVED: Chris	 <a href="http://www.rego.com.tw">http://www.rego.com.tw</a>
.XX ± 0.20	CHECKED: Andy	
.XXX ± 0.15	DRAWN: Vic	
X* ± 3°	UNITS: mm	SCALE: NONE
TITLE: USB Type C 2x1 Port , Right Angle Type		PART NO: 9177USB31-F02005
SHEET: 3		OF 3

A	21.3.2022
REV	DATE

1 2 3 4 5 6 7 8 9 10