

NOTES:

1.MATERIAL:
HOUSING: LCP, UL94V-0, Black
CONTACT: PHOSPHOR BRONZE (C5191)
LATCH: STAINLESS (SUS301)

2.FINISH:
CONTACT:
CONTACT AREA: G/F GOLD PLATED
SOLDER AREA: G/F GOLD PLATED
UNDER PLATING: NICKEL PLATED.
LATCH:
SOLDER AREA: G/F GOLD PLATED
UNDER PLATING: NICKEL PLATED.

3.SPECIFICATION:
CURRENT RATING: 0.5A / (1PIN)
VOLTAGE RATING: 25V AC
DIELECTRIC WITHSTANDING: 125V AC FOR 1 MINUTE
CONTACT RESISTANCE: 60mΩ Max.
INSULATION RESISTANCE: 500MΩ Min
OPERATING TEMPERATURE: -40°C to +85°C
DURABILITY: 25 CYCLES MIN.

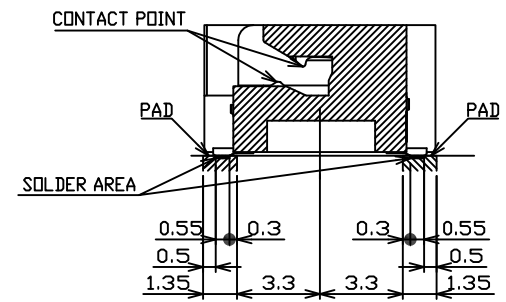

MUST BE MEASURED FLOATING AMOUNT OF CONTACT TAILS FROM DATUM SURFACE IS 0.1mm MAX.

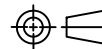
PROPRIETARY NOTE: This document contains confidential information and proprietary to Rego Electronics and shall not be reproduced or disclosed to other documents or used for any purpose other than that for which was obtained without the expressed written consent of Rego Electronics.			
. X ± 0.30	APPROVED:	Chris	 http://www.rego.com.tw TITLE: SO DIMM DDR3 R/A 204 Pins Reverse Type H:5.2mm
. XX ± 0.20	CHECKED:	Andy	
. XXX ± 0.15	DRAWN:	Vic	
X° ± 3°			
 UNITS: mm SCALE: NONE	PART NO: 906DDR3-03B520 SHEET: 1 OF 4		

AO	15.3.2017
REV	DATE

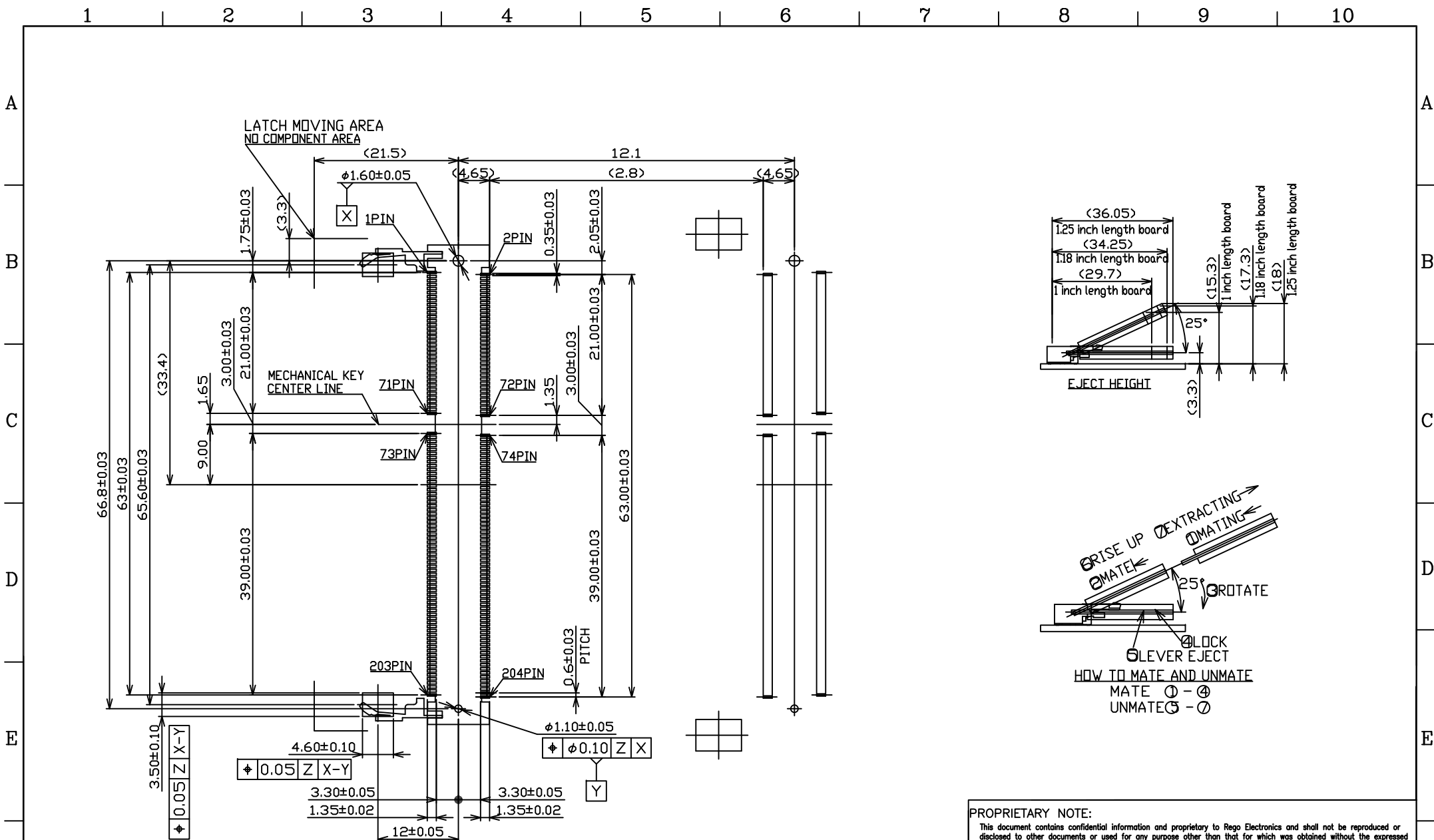

PROPRIETARY NOTE:
This document contains confidential information and proprietary to Rego Electronics and shall not be reproduced or disclosed to other documents or used for any purpose other than that for which was obtained without the expressed written consent of Rego Electronics.

.X ± 0.30	APPROVED:	 http://www.rego.com.tw
.XX ± 0.20	CHECKED: Chris	
.XXX ± 0.15	DRAWN: Andy	
X° ± 3'	SCALE: NONE	TITLE: SO DIMM DDR3 R/A 204 Pins Reverse Type H:5.2mm
UNITS: mm	SCALE: NONE	PART NO: 906DDR3-03B520
		SHEET: 2 OF 4

AO	15.3.2017
REV	DATE

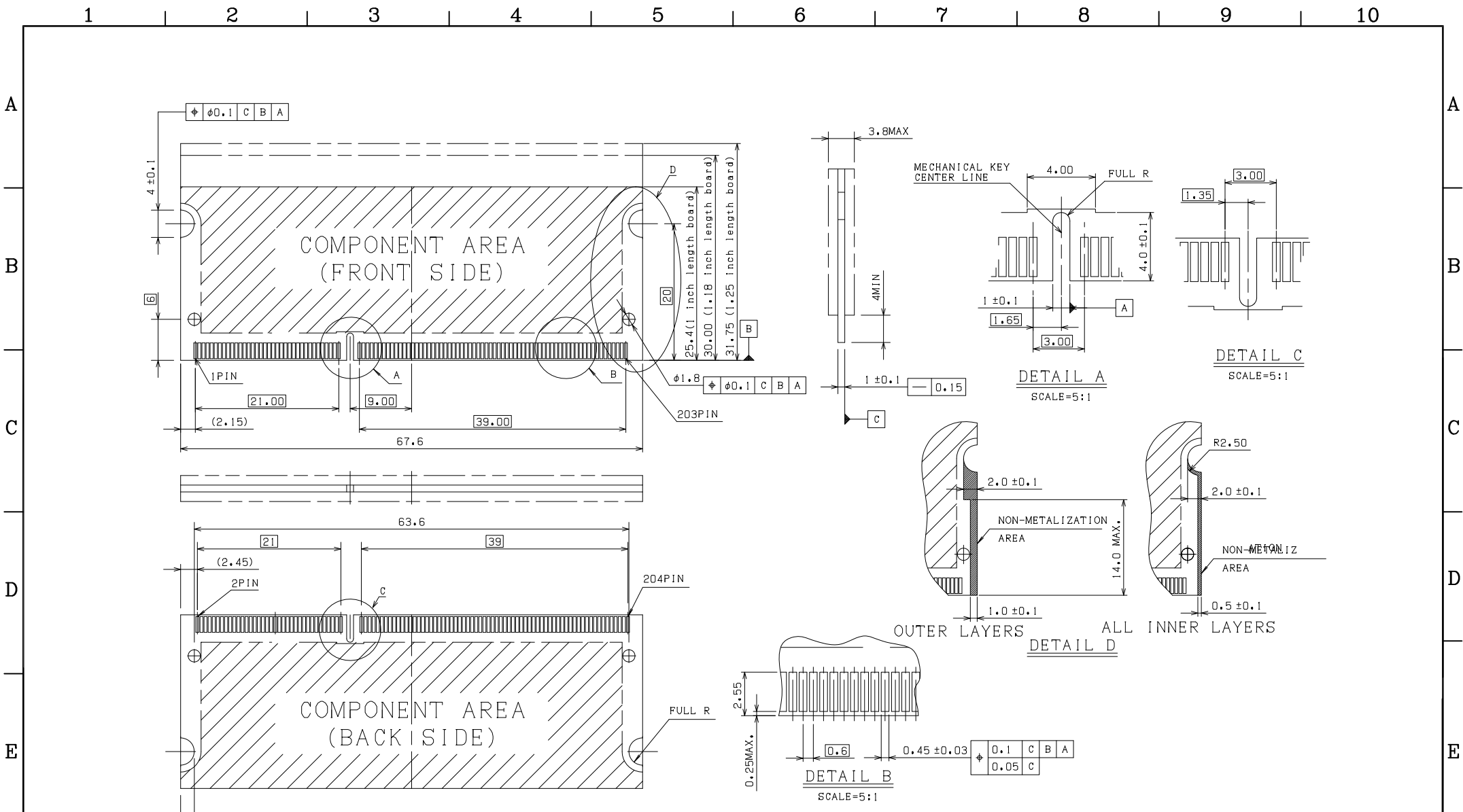

A0	15.3.2017
REV	DATE

PROPRIETARY NOTE: This document contains confidential information and proprietary to Rego Electronics and shall not be reproduced or disclosed to other documents or used for any purpose other than that for which was obtained without the expressed written consent of Rego Electronics.		
.X ± 0.30	APPROVED: Chris	 http://www.rego.com.tw
.XX ± 0.20	CHECKED: Andy	
.XXX ± 0.15	DRAWN: Vic	
X° ± 3'	UNITS: mm	SCALE: NONE
		TITLE: SO DIMM DDR3 R/A 204 Pins Reverse Type H:5.2mm
		PART NO: 906DDR3-03B520
		SHEET: 3 OF 4

1 2 3 4 5 6 7 8 9 10

A
B
C
D
E
F

- NOTES:
- PACKING STYLE: 20 PCS/Tray
220 PCS/INNER CARTON
660 PCS/OUTER CARTON
 - MATERIAL: Tray: PET

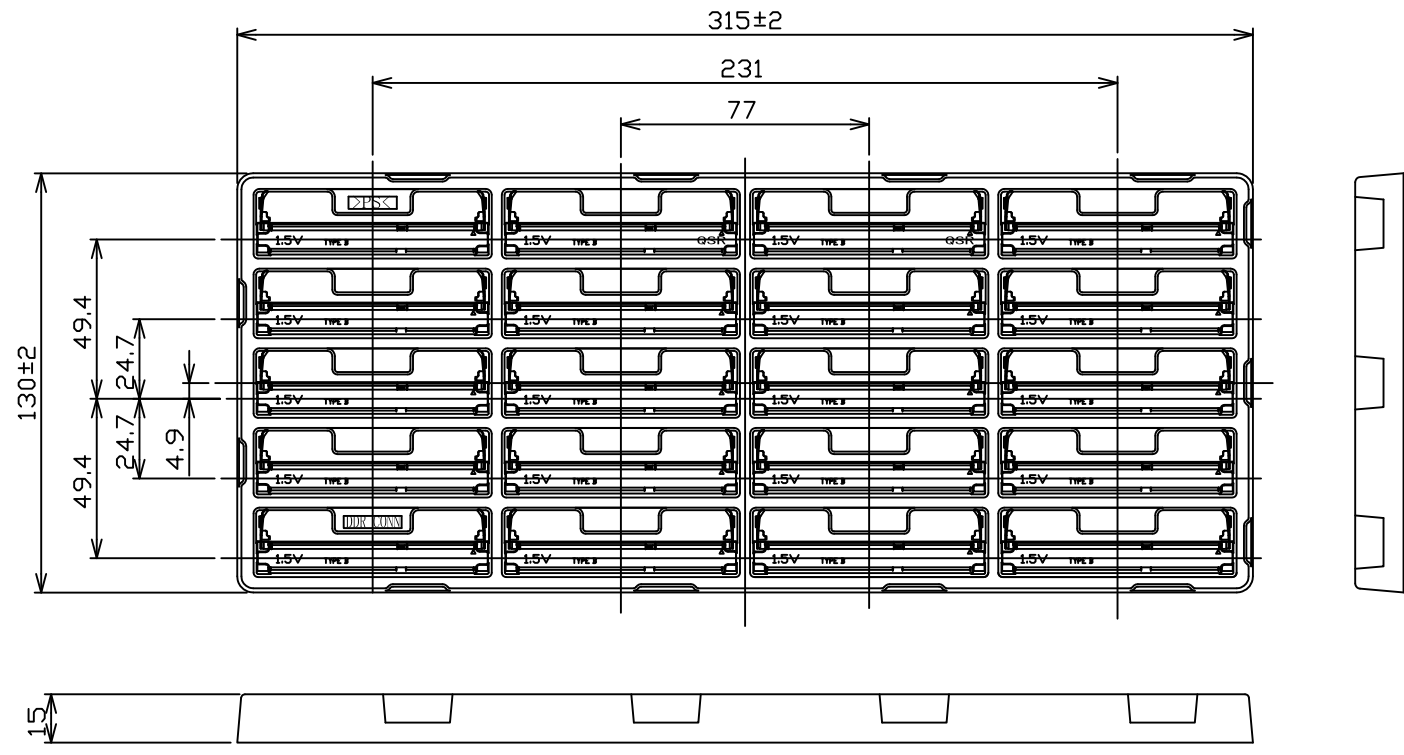

PROPRIETARY NOTE:
This document contains confidential information and proprietary to Rego Electronics and shall not be reproduced or disclosed to other documents or used for any purpose other than that for which was obtained without the expressed written consent of Rego Electronics.

. X ± 0.30	APPROVED: Chris	 http://www.rego.com.tw	
. XX ± 0.20	CHECKED: Andy		
. XXX ± 0.15	DRAWN: Vic		
X° ± 3'	UNITS: mm	SCALE: NONE	TITLE: SO DIMM DDR3 R/A 204 Pins Reverse Type H:5.2mm PART NO: 906DDR3-03B520 SHEET: 4 OF 4

AO	15.3.2017
REV	DATE

1 2 3 4 5 6 7 8 9 10