

1 2 3 4 5 6 7 8 9 10

A

B

C

D

E

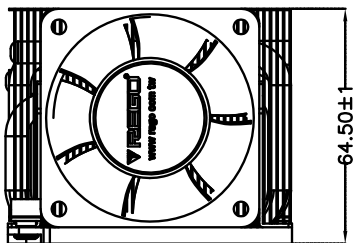
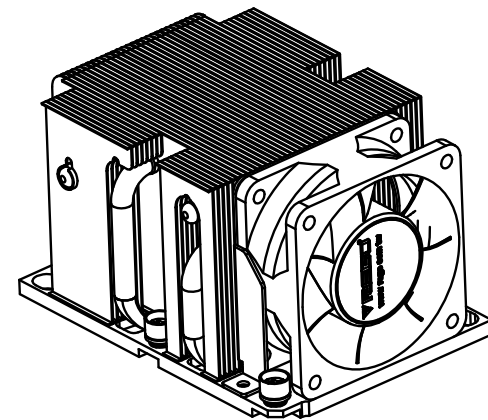
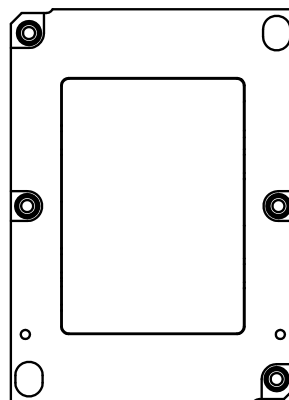
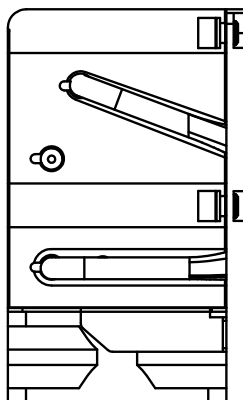
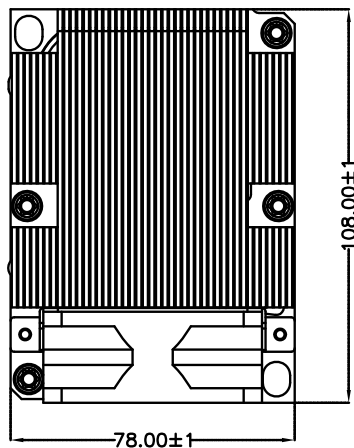
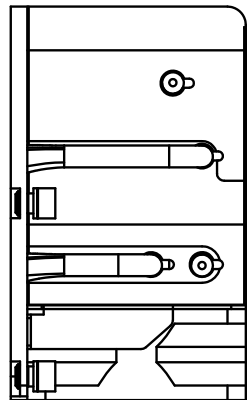

F



64.50±1

PROPRIETARY NOTE:

This document contains confidential information and proprietary to Rego Electronics and shall not be reproduced or disclosed to other documents or used for any purpose other than that for which was obtained without the expressed written consent of Rego Electronics.

.X ± 0.30	APPROVED: Chris	 <a href="http://www.rego.com.tw">http://www.rego.com.tw</a>
.XX ± 0.20	CHECKED: Levi	
.XXX ± 0.15	DRAWN: Vic	
X* ± 3*		
	UNITS: mm	SCALE: NONE
		TITLE: 2U CPU Cooler for Intel Socket LGA3647 Processors
		PART NO: RG9223
		SHEET: 1 of 1

A	29.4.2021
REV	DATE

1 2 3 4 5 6 7 8 9 10