

1 2 3 4 5 6 7 8 9 10

A
B
C
D
E
F

$\phi 5.50 \pm 0.10$

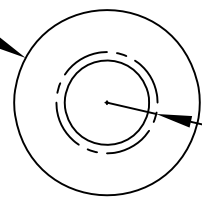

M3x0.5 Tapped Hole-Thru

NOTES:

- 1. MATEREAL
- 1-1. BRASS.
- 1-2. FINISH: NICKEL (30~150u") UNDERPLATING ALL OVER BASE MATERIAL. MATTE TIN (40~80u") PLATING OVER UNDERPLATE.

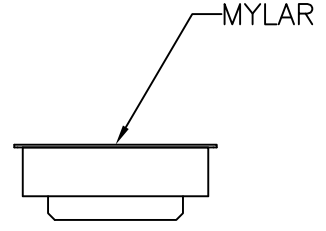
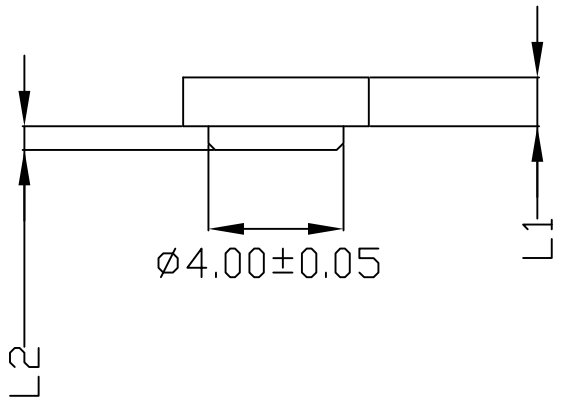

TABLE

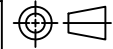
PART NO.	L1	L2	PROPRIETARY NOTE: This document contains confidential information and proprietary to Rego Electronics and shall not be reproduced or disclosed to other documents or used for any purpose other than that for which was obtained without the expressed written consent of Rego Electronics.			
S001-00001-A32-R	1.45±0.05	1.40±0.05	.X ± 0.30	APPROVED: Chris	 <p>TITLE: NGFF STANDOFF A TYPE (TAPE & REEL)</p>	
S001-00001-A42-R	2.45±0.05	0.70±0.05	.XX ± 0.20	CHECKED: Denny		
S001-00001-A67-R	4.95±0.05	0.70±0.05	.XXX ± 0.15	DRAWN: Bryan		
S001-00001-A85-R	6.60±0.05	0.70±0.05	X* ± 3*			
				UNITS: mm	SCALE: NONE	PART NO: S001-00001-Axx-R
					SHEET: 1 of 1	

A	04.02.2018
REV	DATE

1 2 3 4 5 6 7 8 9 10

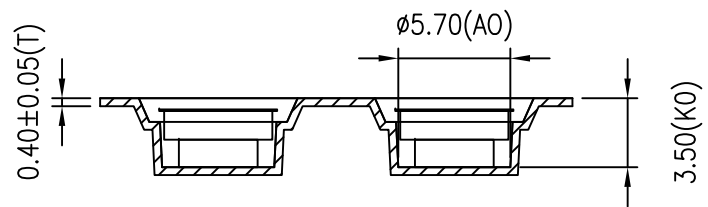
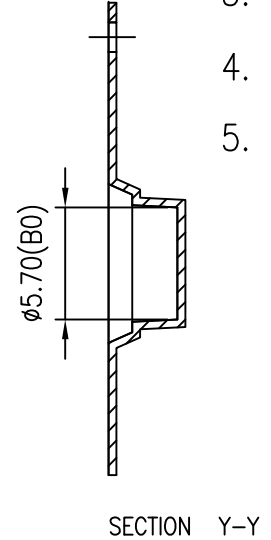
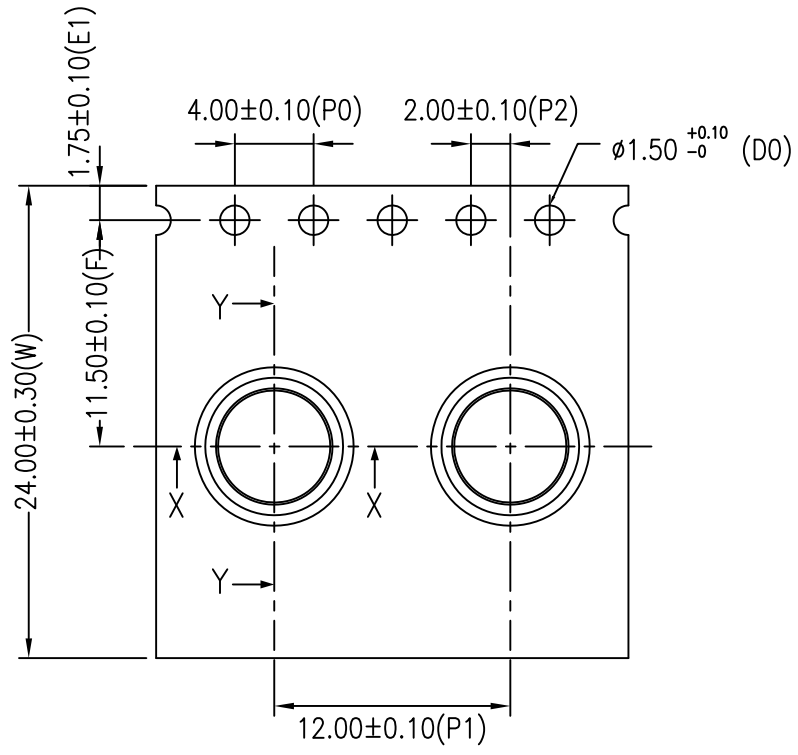

1. Part conforms to EIA-481-D standards.
2. All dimensions in millimetres unless otherwise stated.
3. Material : Conductive polystyrene.
4. Packing length for 22" reel : 57.0 Meters. (1:3)
5. Component packing to 13" reel : 1500 pcs.

A0	$\phi 5.70 \pm 0.20$
B0	$\phi 5.70 \pm 0.20$
K0	3.50 ± 0.20
K1	

SECTION X-X

SECTION Y-Y

A	21.2.2018
REV	DATE

PROPRIETARY NOTE:
 This document contains confidential information and proprietary to Rego Electronics and shall not be reproduced or disclosed to other documents or used for any purpose other than that for which was obtained without the expressed written consent of Rego Electronics.

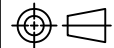
.X ± 0.30	APPROVED: Chris	 http://www.rego.com.tw	
.XX ± 0.20	CHECKED: Denny		
.XXX ± 0.15	DRAWN: Bryan		
X' ± 3'		TITLE: PACKING INFORMATION	
	UNITS: mm	SCALE: NONE	PART NO: S001-00001-A32-R
			SHEET: 1 OF 1

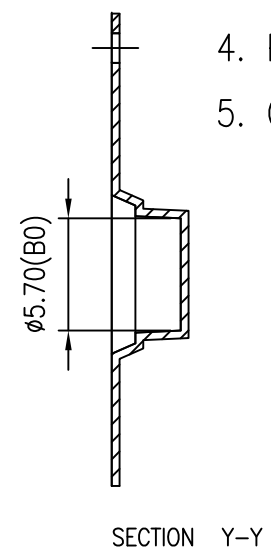
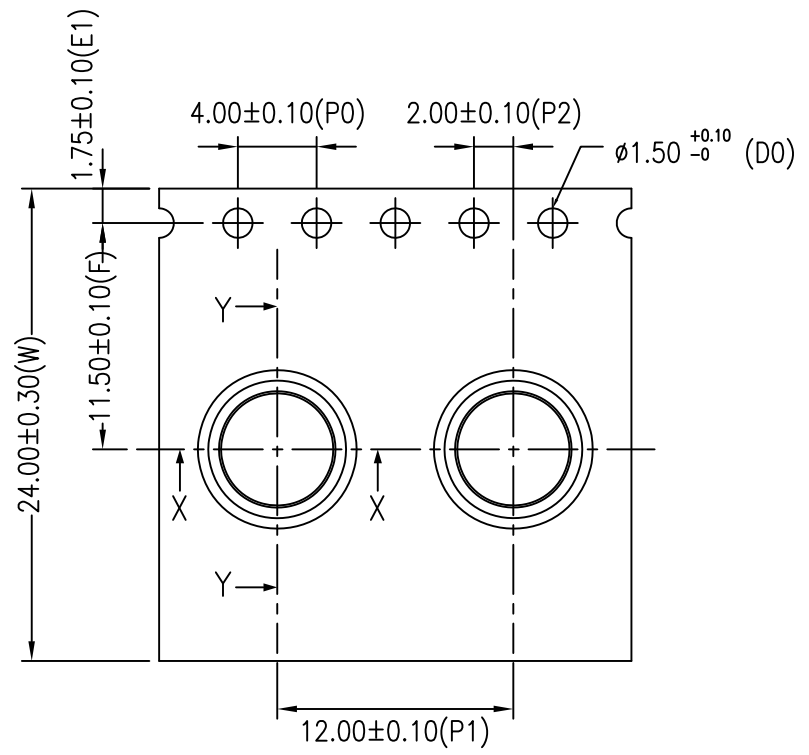

A0	$\phi 5.70 \pm 0.20$
B0	$\phi 5.70 \pm 0.20$
K0	3.50 ± 0.20
K1	

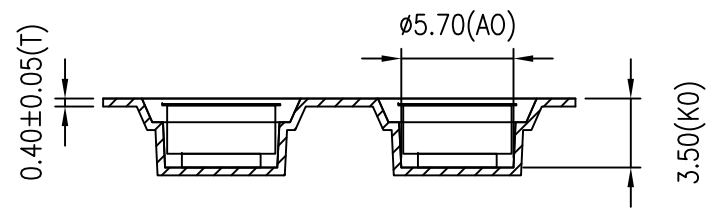

SECTION X-X

1. Part conforms to EIA-481-D standards.
2. All dimensions in millimetres unless otherwise stated.
3. Material : Conductive polystyrene.
4. Packing length for 22" reel : 57.0 Meters. (1:3)
5. Component packing to 13" reel : 1500 pcs.

A	21.2.2018
REV	DATE

PROPRIETARY NOTE:
 This document contains confidential information and proprietary to Rego Electronics and shall not be reproduced or disclosed to other documents or used for any purpose other than that for which was obtained without the expressed written consent of Rego Electronics.

.X ± 0.30	APPROVED: Chris		
.XX ± 0.20	CHECKED: Denny		
.XXX ± 0.15	DRAWN: Bryan		
X' ± 3'		TITLE: PACKING INFORMATION	
	UNITS: mm	SCALE: NONE	PART NO: S001-00001-A42-R
			SHEET: 1 OF 1

1 2 3 4 5 6 7 8 9 10

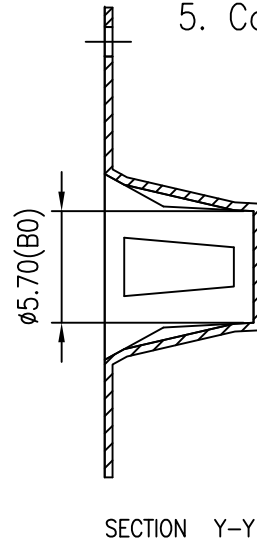
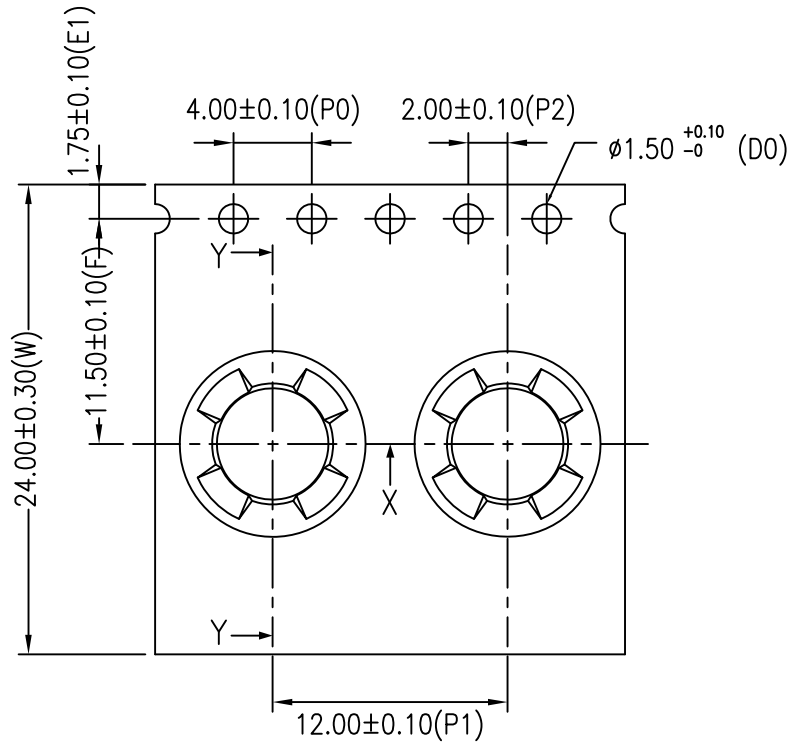

A
B
C
D
E
F

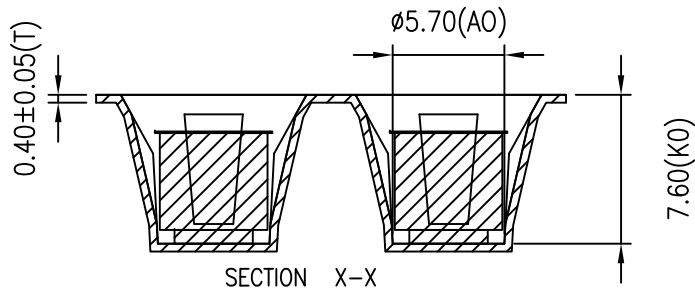

1. Part conforms to EIA-481-D standards.
2. All dimensions in millimetres unless otherwise stated.
3. Material : Conductive polystyrene.
4. Packing length for 22" reel : 24.0 Meters. (1:3)
5. Component packing to 13" reel : 600 pcs.

A0	φ5.70 ±0.20
B0	φ5.70 ±0.20
K0	7.60 ±0.20
K1	



PROPRIETARY NOTE: This document contains confidential information and proprietary to Rego Electronics and shall not be reproduced or disclosed to other documents or used for any purpose other than that for which was obtained without the expressed written consent of Rego Electronics.			
.X ± 0.30	APPROVED:	 http://www.rego.com.tw	TITLE: PACKING INFORMATION
.XX ± 0.20	CHECKED:		
.XXX ± 0.15	DRAWN:		
X' ± 3'			
	UNITS:	SCALE:	PART NO: S001-00001-A67-R
	mm	NONE	SHEET: 1 OF 1

A	21.2.2018
REV	DATE

1 2 3 4 5 6 7 8 9 10

1 2 3 4 5 6 7 8 9 10

A
B
C
D
E
F

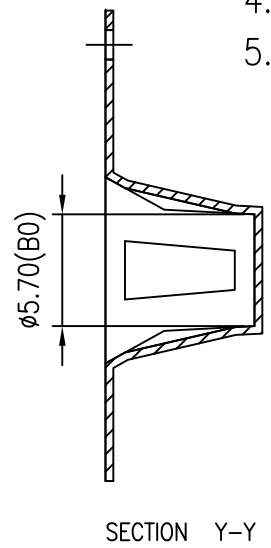
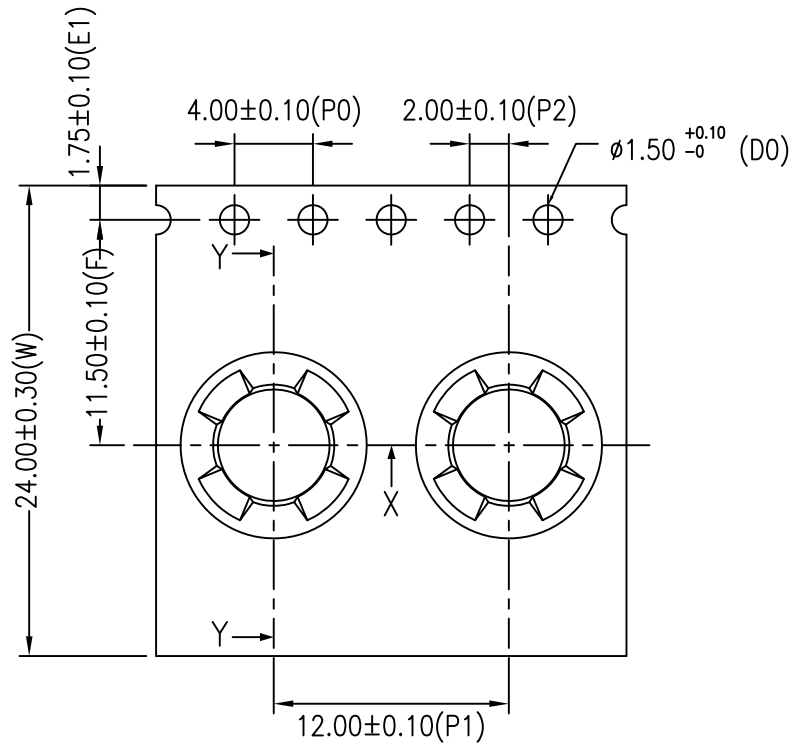

A0	$\phi 5.70 \pm 0.20$
B0	$\phi 5.70 \pm 0.20$
K0	7.60 ± 0.20
K1	

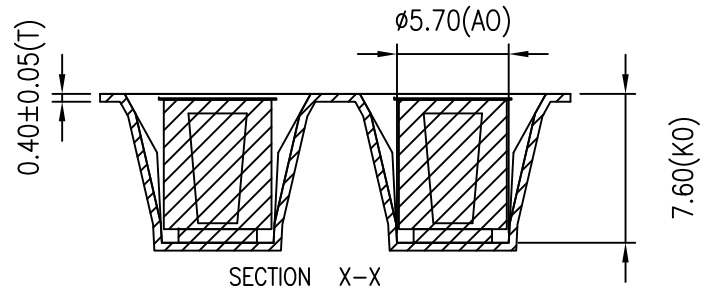

1. Part conforms to EIA-481-D standards.
2. All dimensions in millimetres unless otherwise stated.
3. Material : Conductive polystyrene.
4. Packing length for 22" reel : 24.0 Meters. (1:3)
5. Component packing to 13" reel : 600 pcs.

A	21.2.2018
REV	DATE

PROPRIETARY NOTE:
This document contains confidential information and proprietary to Rego Electronics and shall not be reproduced or disclosed to other documents or used for any purpose other than that for which was obtained without the expressed written consent of Rego Electronics.

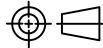
.X ± 0.30	APPROVED: Chris	 http://www.rego.com.tw	
.XX ± 0.20	CHECKED: Denny		
.XXX ± 0.15	DRAWN: Bryan		
X' ± 3'	TITLE: PACKING INFORMATION		
	UNITS: mm	SCALE: NONE	PART NO: S001-00001-A85-R
	SHEET: 1 OF 1		

1 2 3 4 5 6 7 8 9 10