

ITEM	PART NAME	QTY	MATERIAL	FINISH
1	BODY	1	LCP	
2	UPPER CONTACT	34	PHOSPHOR BRONZE	GOLD PLATING
3	UPPER CONTACT	33	PHOSPHOR BRONZE	GOLD PLATING
4	HOLD DOWN	2	BRASS	TIN 100u"

RECOMMEND NGFF MINI CARD MOUNTING TYPE_SMT_PCB OUTLIN :
GENERAL TOLERANCE ±0.05mm

PROPRIETARY NOTE:
This document contains confidential information and proprietary to Rego Electronics and shall not be reproduced or disclosed to other documents or used for any purpose other than that for which was obtained without the expressed written consent of Rego Electronics.

.X ± 0.30	APPROVED: Chris	 http://www.rego.com.tw
.XX ± 0.20	CHECKED: Andy	
.XXX ± 0.15	DRAWN: Vic	
X* ± 3'		
UNITS: mm	SCALE: NONE	TITLE: M.2 Connector 2.15H M Key Type
		PART NO: 906M2-042M0
		SHEET: 1 OF 2

TABLE 1:

SERIES NUMBER	H1	H2
906M2-042M0(2.0H)	2.20	1.00

MATING CONDITION SCALE: 2:1

A	08.4.2017
REV	DATE

1 2 3 4 5 6 7 8 9 10

A
B
C
D
E
F

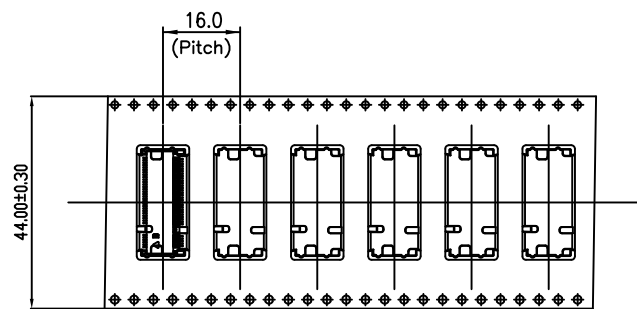

- NOTES:
 1. PACKING STYLE 1200 PCS/REEL
 7200 PCS/OUTER CARTON
 2. MATERIAL CARRIER TAPE:PS BLACK
 COVER TAPE:PET FILM
 REEL:PLASTIC
 3. PEEL STRENGTH OF COVER TAPE:20-80g(PEEL SPEED 300mm/MINUTE).

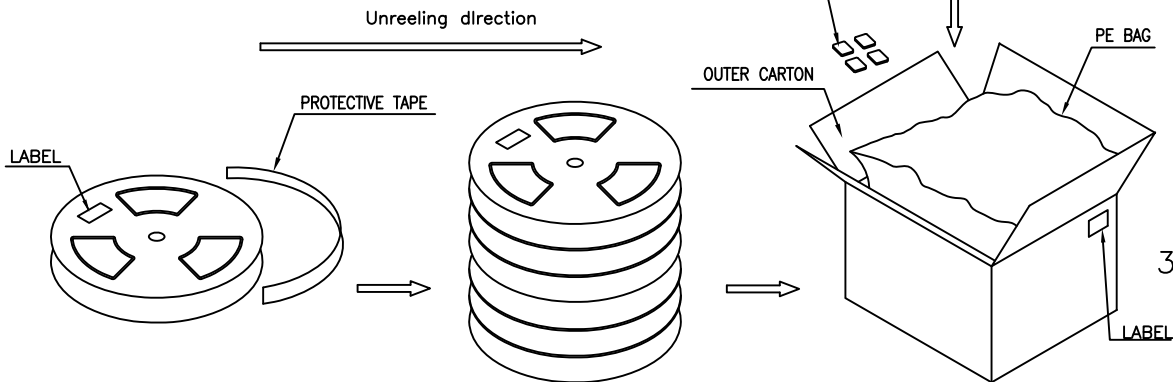
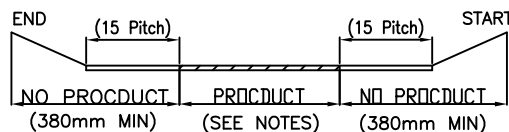
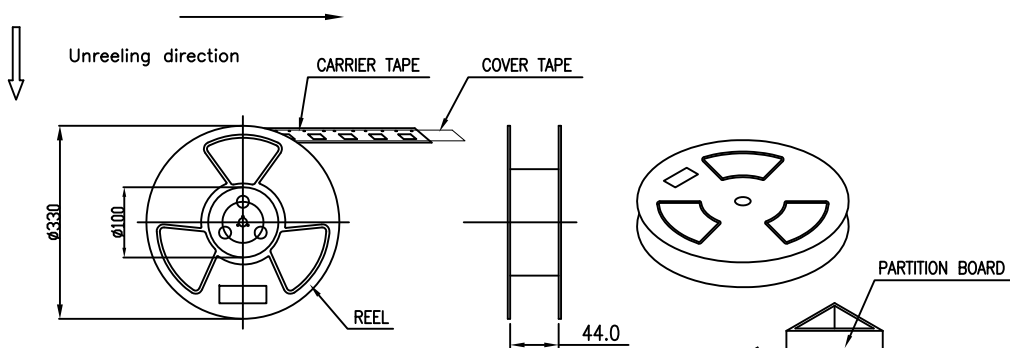

350*350*320mm

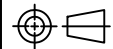
PROPRIETARY NOTE: This document contains confidential information and proprietary to Rego Electronics and shall not be reproduced or disclosed to other documents or used for any purpose other than that for which was obtained without the expressed written consent of Rego Electronics.		
.X ± 0.30	APPROVED: Chris	 http://www.rego.com.tw
.XX ± 0.20	CHECKED: Andy	
.XXX ± 0.15	DRAWN: Vic	TITLE: M.2 Connector 2.15H M Key Type
X* ± 3'	UNITS: mm	PART NO: 906M2-042M0
	SCALE: NONE	SHEET: 2 OF 2

A	08.4.2017
REV	DATE

1 2 3 4 5 6 7 8 9 10