

1 2 3 4 5 6 7 8 9 10

A  
B  
C  
D  
E  
F

ASSEMBLY PARTS

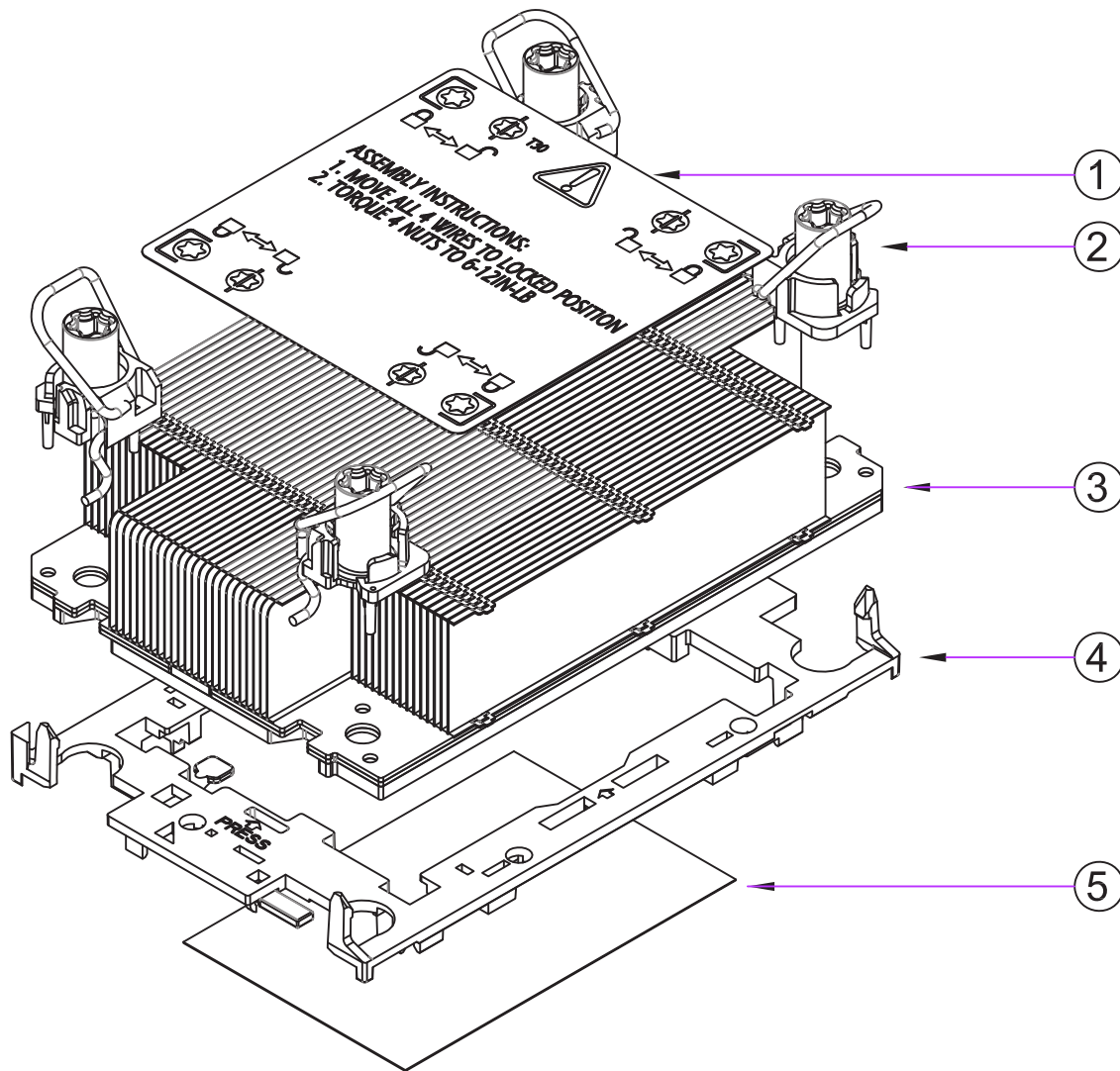

**NOTES:**

1. THE FIGURE IS FOR REFERENCE ONLY, AND NOT FOR SCALE
2. OVERALL DIMENSION : 113 x 78 x 25 mm
3. OVERALL WEIGHT : 520 g

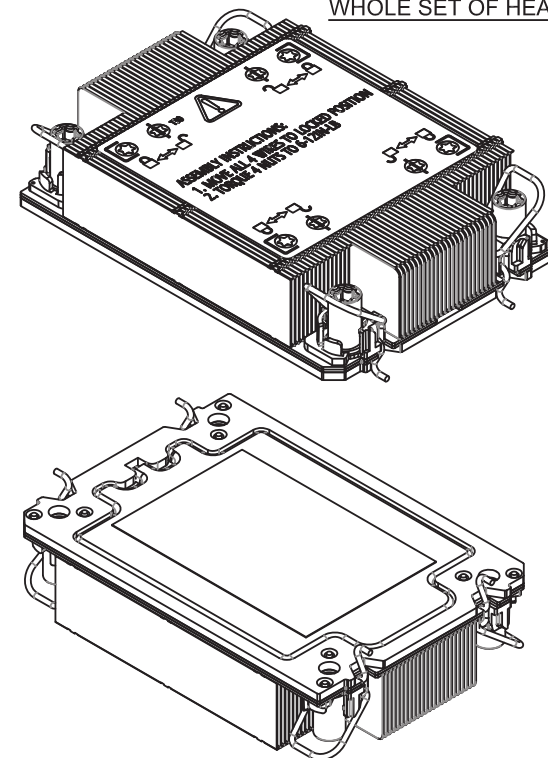

WHOLE SET OF HEATSINK



5	THERMAL GREASE, PRE-PRINTED	SHIN-ETSU 7762	1
4	INTEL PACKAGE CARRIER	PLASTIC	1
3	HEATSINK, with STACKED FINs	COPPER FIN STACK COPPER VAPOR CHAMBER BASE STEEL RETENTION	1
2	ANTI-TILT ROTATING WIRE ASSEMBLY SET	PLASTIC NUT AND CAPTIVATION STEEL ROTATING WIRE	4
1	MOUNTING INSTRUCTION LABEL	PLASTIC	1
ITEM#	DESCRIPTION	MATERIAL	QTY.

**PROPRIETARY NOTE:**

This document contains confidential information and proprietary to Rego Electronics and shall not be reproduced or disclosed to other documents or used for any purpose other than that for which was obtained without the expressed written consent of Rego Electronics.

.X ± 0.30	APPROVED: Chris	 <a href="http://www.rego.com.tw">http://www.rego.com.tw</a>
.XX ± 0.20	CHECKED: Andy	
.XXX ± 0.15	DRAWN: Vic	
X° ± 3'		
 UNITS: mm	SCALE: NONE	TITLE: 1U Passive CPU Cooler for Intel Socket LGA4189 Processors  PART NO: RGA120-P SHEET: 1 OF 10

0.0	03.7.2019
REV	DATE

1 2 3 4 5 6 7 8 9 10

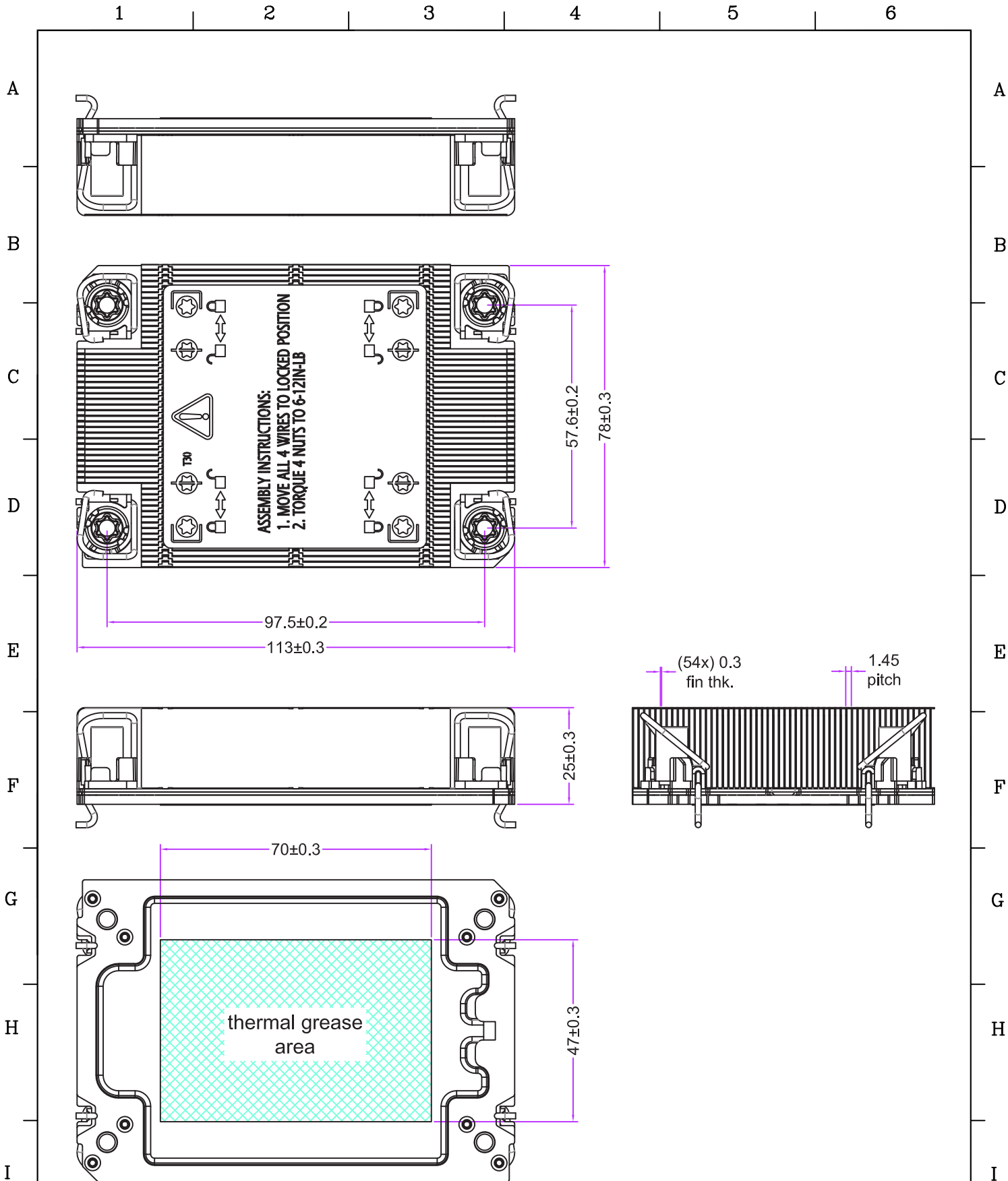

**PROPRIETARY NOTE:**  
 This document contains confidential information and proprietary to Rego Electronics and shall not be reproduced or disclosed to other documents or used for any purpose other than that for which was obtained without the expressed written consent of Rego Electronics.

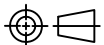
.X ± 0.30	APPROVED: Chris	 <a href="http://www.rego.com.tw">http://www.rego.com.tw</a>
.XX ± 0.20	CHECKED: Levi	
.XXX ± 0.15	DRAWN: Vic	
X* ± 3'		
	UNITS: mm	SCALE: NONE
		TITLE: 1U Passive CPU Cooler for Intel Socket LGA4189 Processors
		PART NO: RGA120-P
		SHEET: 1 OF 1

0.0	03.7.2019
REV	DATE