

Signal Segment	
Name	Type
S1	GND
S2	A+
S3	A-
S4	GND
S5	B-
S6	B+
S7	GND

Power Segment			
Name	Type	Name	Type
P1	V33	P9	V5
P2	V33	P10	GND
P3	V33	P11	DAS/DSS
P4	GND	P12	GND
P5	GND	P13	V12
P6	GND	P14	V12
P7	V5	P15	V12
P8	V5		

NOTES:

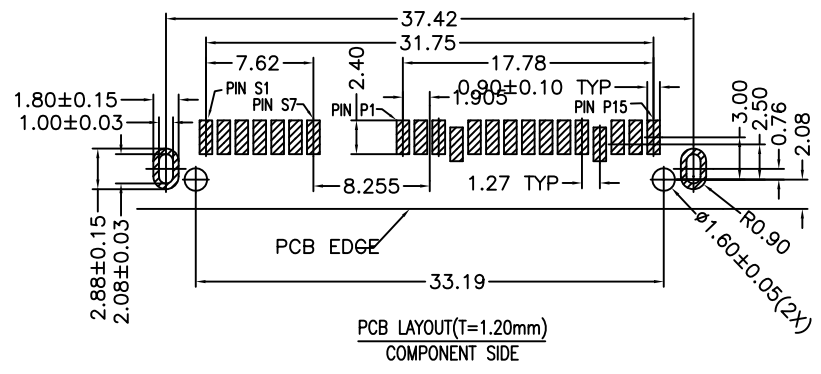
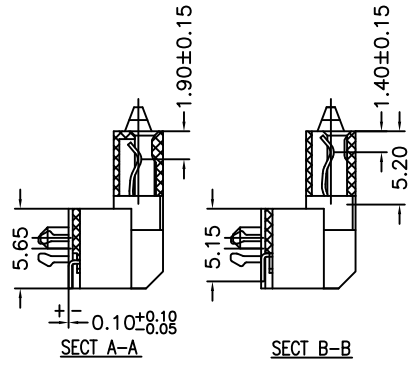
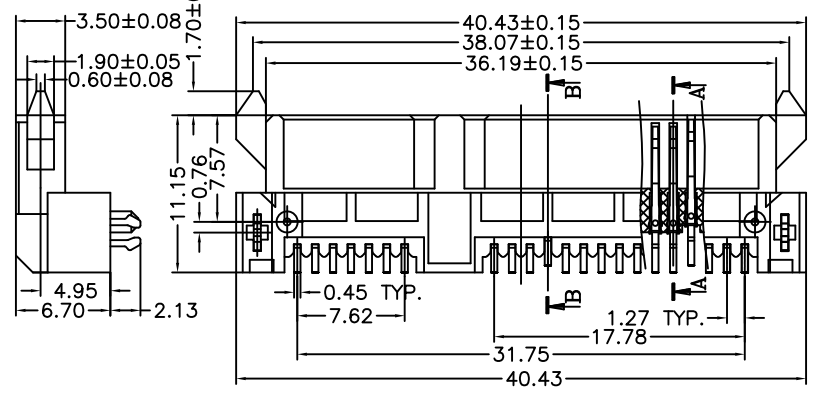

- Material:  
Housing: LCP+50%G.F, UL 94V-0 Rated.  
Color: Black.  
Contact: Phosphor Bronze.  
Plating: Gold Plating over Nickel on Contact Area.  
Tin Plating on Solder Tail.  
Harpoon: Brass.  
Plating: Tin Plating over Nickel.
- Mechanical:  
Insertion Force: 45N Max.  
Withdrawal Force: 10N Min.  
Durability: 500 Cycles
- Electrical Specification:  
Operation Voltage: 100VAC Max.  
Current Rating: 1.5 Ampere per Contact.  
Contact Resistance: 30mΩ Max.  
Insulation Resistance: 1000MΩ Min.  
Dielectric Withstanding Voltage: 500 VAC.
- Environmental:  
Operating Temperature: -55°C to +85°C

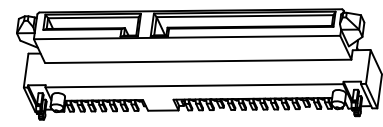
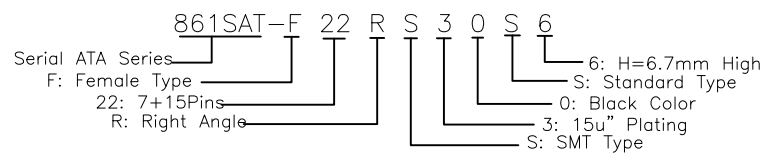

Part Number:



Product 3D

PROPRIETARY NOTE: This document contains confidential information and proprietary to Rego Electronics and shall not be reproduced or disclosed to other documents or used for any purpose other than that for which was obtained without the expressed written consent of Rego Electronics.		
.X ± 0.30	APPROVED: Chris	 <a href="http://www.rego.com.tw">http://www.rego.com.tw</a> TITLE: Serial ATA 7+15P Female, Right Angle Standard Type, SMT, H:6.7mm PART NO: 861SAT-F22RS30S6 SHEET: 1 OF 1
.XX ± 0.20	CHECKED: Denny	
.XXX ± 0.15	DRAWN: Bryan	
X° ± 3'		
 UNITS: mm SCALE: NONE		

A	RELEASE	01.15.2007
REV	DESCRIPTION	DATE