

A
B
C
D
E
F

A
B
C
D
E
F

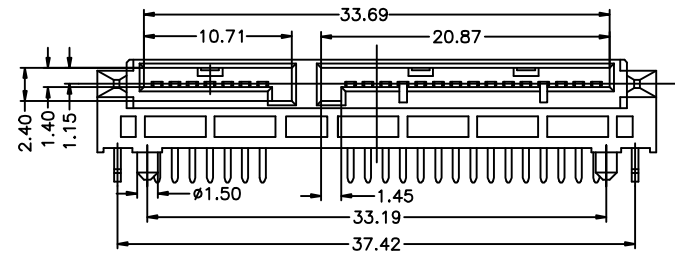

Signal Segment		Power Segment			
Name	Type	Name	Type	Name	Type
S1	GND	P1	V33	P9	V5
S2	A+	P2	V33	P10	GND
S3	A-	P3	V33	P11	DAS/DSS
S4	GND	P4	GND	P12	GND
S5	B-	P5	GND	P13	V12
S6	B+	P6	GND	P14	V12
S7	GND	P7	V5	P15	V12
		P8	V5		

NOTES:

- Material:
Housing: LCP+50%G.F, UL 94V-0 Rated.
Color: Black.
Contact: Phosphor Bronze.
Plating: Gold Plating over Nickel on Contact Area.
Tin Plating on Solder Tail.
Harpoon: Brass.
Plating: Tin Plating over Nickel.
- Mechanical:
Insertion Force: 45N Max.
Withdrawal Force: 10N Min.
Durability: 500 Cycles
- Electrical Specification:
Operation Voltage: 100VAC Max.
Current Rating: 1.5 Ampere per Contact.
Contact Resistance: 30mΩ Max.
Insulation Resistance: 1000MΩ Min.
Dielectric Withstanding Voltage: 500 VAC.
- Environmental:
Operating Temperature: -55°C to +85°C

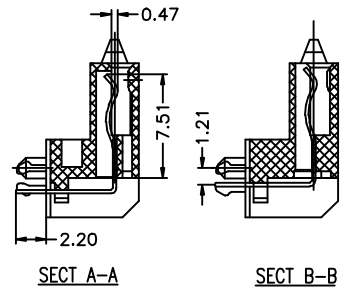
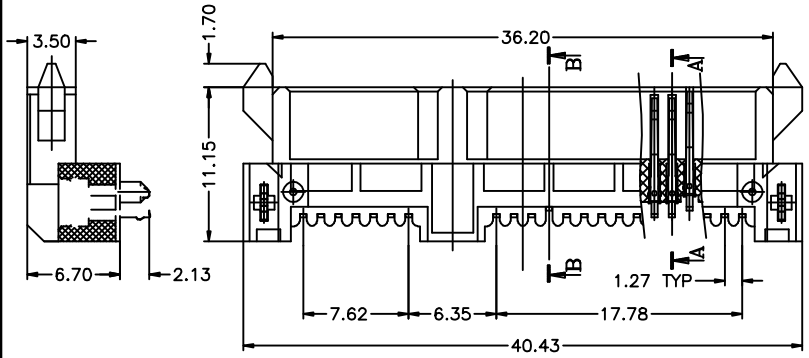

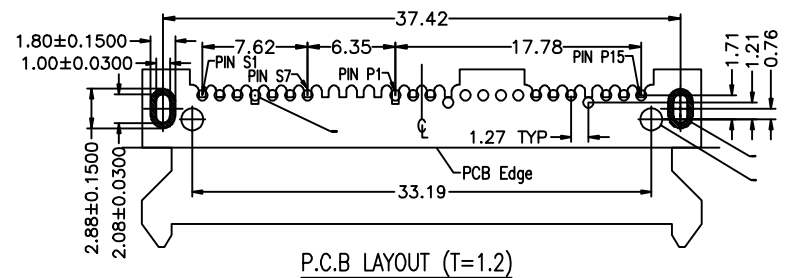
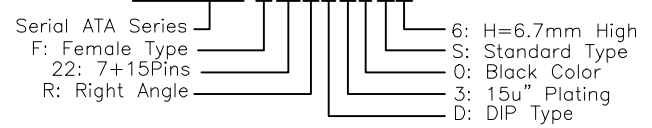

Part Number:

861SAT-F22RD30S6



PROPRIETARY NOTE:
This document contains confidential information and proprietary to Rego Electronics and shall not be reproduced or disclosed to other documents or used for any purpose other than that for which was obtained without the expressed written consent of Rego Electronics.

.X ± 0.30	APPROVED: Chris	 http://www.rego.com.tw
.XX ± 0.20	CHECKED: Denny	
.XXX ± 0.15	DRAWN: Bryan	TITLE: Serial ATA 7+15P Female, Right Angle Standard Type, DIP, H:6.7mm
X* ± 3'		PART NO: 861SAT-F22RD30S6
	UNITS: mm	SCALE: NONE

A	RELEASE	01.15.2007
REV	DESCRIPTION	DATE