

1 2 3 4 5 6 7 8 9 10

A

B

C

D

E

F

A

B

C

D

E

F

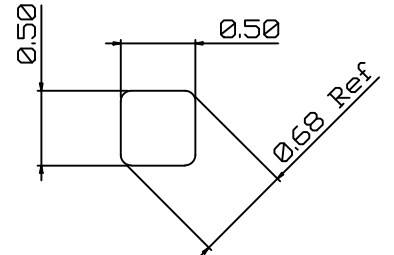
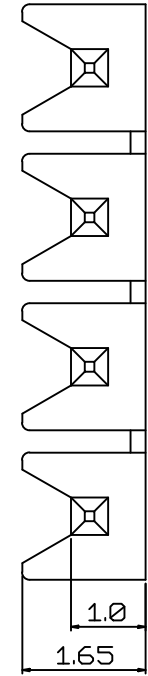
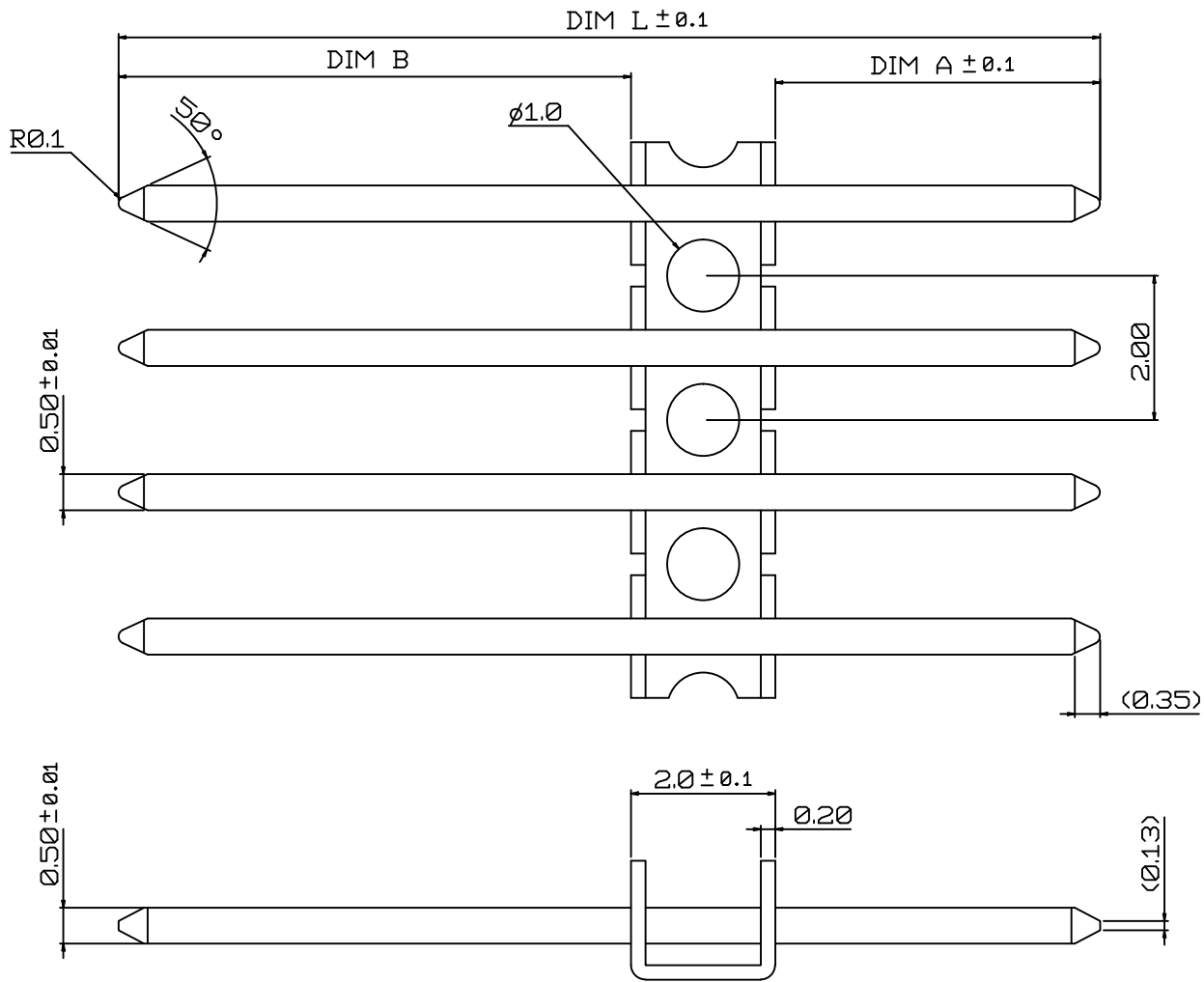

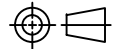
PROPRIETARY NOTE: This document contains confidential information and proprietary to Rego Electronics and shall not be reproduced or disclosed to other documents or used for any purpose other than that for which was obtained without the expressed written consent of Rego Electronics.		
.X ± 0.30	APPROVED: Chris	 http://www.rego.com.tw TITLE: 0.50mm sq. bandolier pin 2.00mm pitch
.XX ± 0.20	CHECKED: Denny	
.XXX ± 0.15	DRAWN: Bryan	
X* ± 3'		
 UNITS: mm	SCALE: NONE	PART NO: KB05000
		SHEET: 1 OF 1

A	RELEASE	04.01.2008
REV	DESCRIPTION	DATE

1 2 3 4 5 6 7 8 9 10