

1 2 3 4 5 6 7 8 9 10

A

B

C

D

E

F

A

B

C

D

E

F

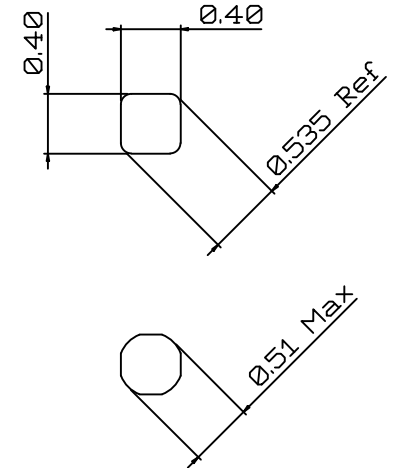
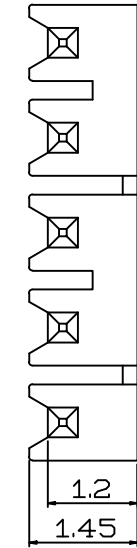
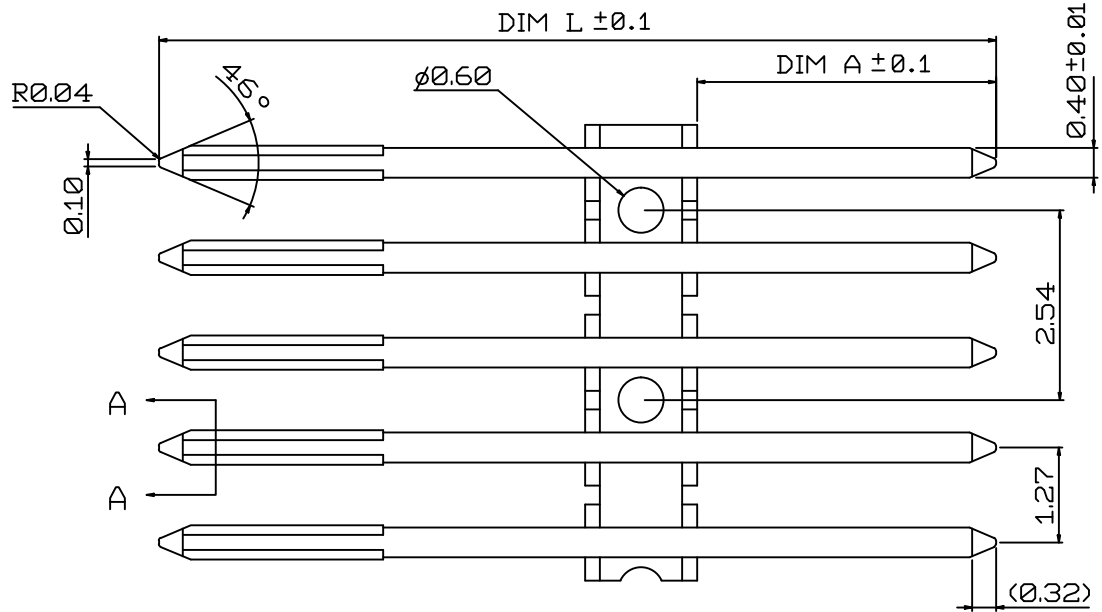

SECTION A-A

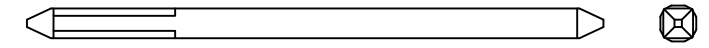
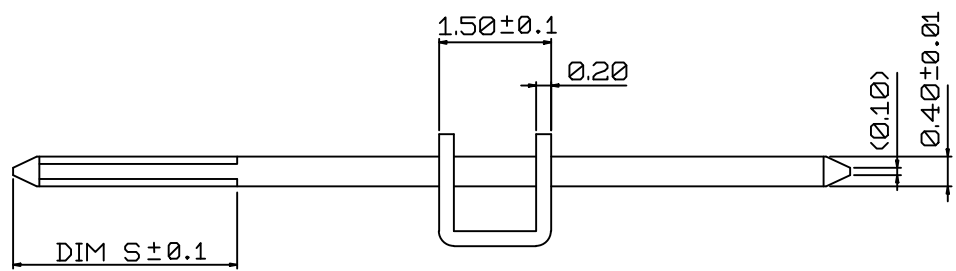

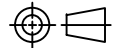
<b>PROPRIETARY NOTE:</b> This document contains confidential information and proprietary to Rego Electronics and shall not be reproduced or disclosed to other documents or used for any purpose other than that for which was obtained without the expressed written consent of Rego Electronics.			
.X $\pm 0.30$	APPROVED: Chris	 <a href="http://www.rego.com.tw">http://www.rego.com.tw</a>	
.XX $\pm 0.20$	CHECKED: Denny		
.XXX $\pm 0.15$	DRAWN: Bryan		
X* $\pm 3'$			
	UNITS: mm	SCALE: NONE	TITLE: 0.40mm sq. bandolier pin round type 1.27mm pitch PART NO: KB04060 SHEET: 1 OF 1

A	RELEASE	04.01.2008
REV	DESCRIPTION	DATE

1 2 3 4 5 6 7 8 9 10